



Metals + Architectural Products



COLUMN COVERS



# EASY-TO-ASSEMBLE COLUMN COVERS

For over twenty-five years, Móz Designs has provided pre-engineered column covers to conceal structural elements for the design and construction industry utilizing our signature colors and grains. Today we are proud to offer more durable finish options such as powder and kynar coatings in addition to brushed stainless steel thus bringing Móz Easy-to-Assemble Column Covers to a wider network.

## When we say “easy” we mean it.

- Reliable customer service
- Standard CAD details, spec sheets, and an easy-to-use quote request form online
- Pre-formed and finished column sections with all brackets, angles, trims and clips included
- Design assistance & value engineering
- Versatile wet or dry joint system
- Shop drawing submittals and installation instructions
- Affordable material and finish options including
- Exterior options with 10 to 20 year warranty

## Our Carbon Footprint

Móz products are proudly made in the USA where our company was founded in Oakland California. All raw materials are domestically source when possible and our 30,000 square foot facility is 100% solar powered to ensure we leave the smallest carbon footprint.

## About Us

Móz Designs has been providing specialty architectural metal products for over 25 years. Our manufacturing capabilities include: plate rolling up to 13', CNC brake forming, CNC punch press, CNC router, MIG/TIG welding, water jet and laser cutting. Contact us or visit our website for more information to help with your next project – [mozdesigns.com](http://mozdesigns.com).



# SHAPES

Available in a variety of standard shapes and sizes.  
 Partial and custom shapes also available; contact us.

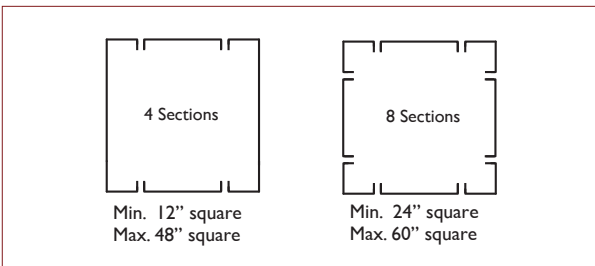
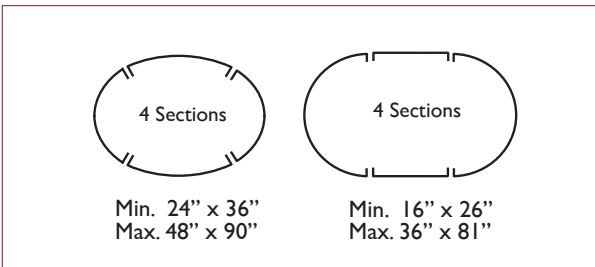
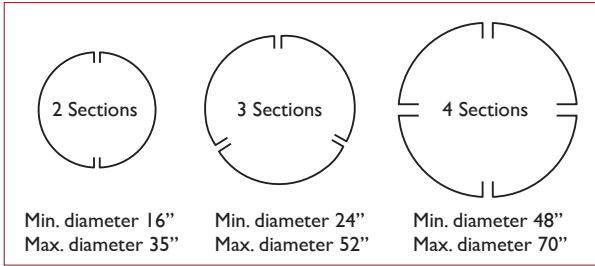

12' tall columns in one section.  
 Taller columns will require stacked segments.

# DETAILS

Pre-rolled and formed metal surrounds with key slot attachment to mount direct to metal studs (by others).

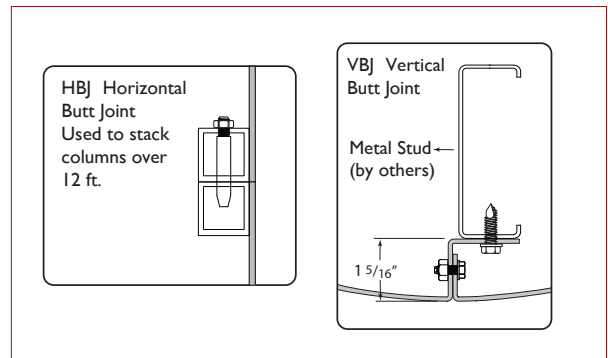
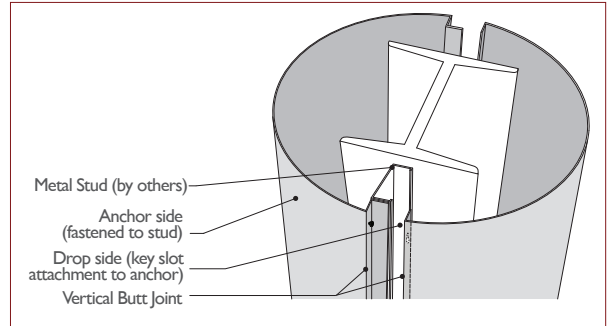

Standard Vertical & Horizontal Butt Joints allow for a clean, precise installation, revealing only a hairline joint.

Columns can also direct mount to existing concrete piers.

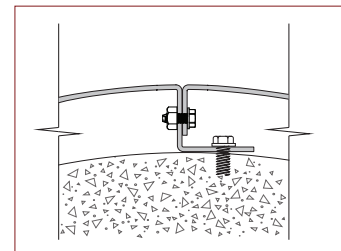

# OTHER OPTIONS

- Open Reveals (horizontal & vertical)
- Recessed Base and/or Capital
- Protruding Base and/or Capital
- Cap Closures
- Sound Deadening
- Internal Support Post (factory post)
- Custom Cut Outs
- Perforated
- Tapering Shapes
- Custom Colors
- Exterior Finishes

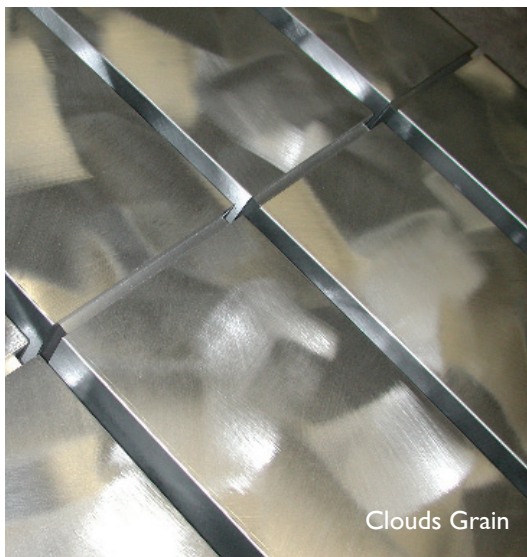
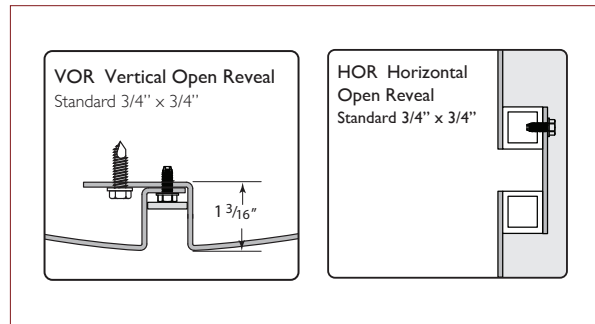

Clouds Grain



Classic Mahogany on Bamboo Grain

# MATERIALS

Móz column covers offer variety and possibilities, with a more **affordable** price point and hundreds of color options not typically available. Our simple specification process makes it easy to choose the options that fit your project's budget and installation environment.

**Móz Column Covers are available in a variety of materials and finishes to meet your needs:**

## **Aluminum** — standard .090" thickness (up to .125")

- Unique Móz Color Collections and Grain Patterns
- Móz Engravings
- Perforated
- Powder Coating **NEW**
- Fluoropolymer (PVDF) Coatings **NEW**  
(10-20 year exterior warranty)

## **Stainless Steel** — standard 18 ga (up to 16 ga)

- Unique Móz Grain Patterns
- Brushed #4
- Polished #8
- Embossed

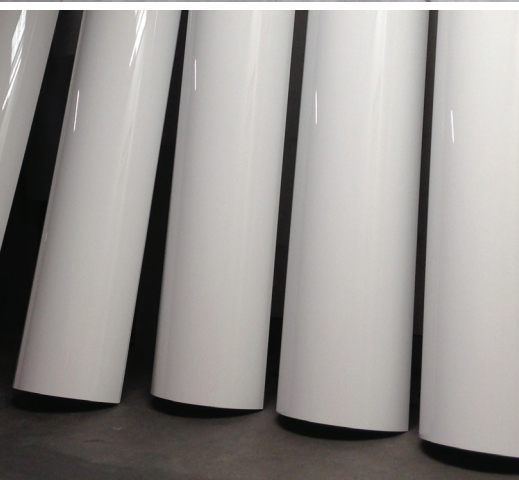
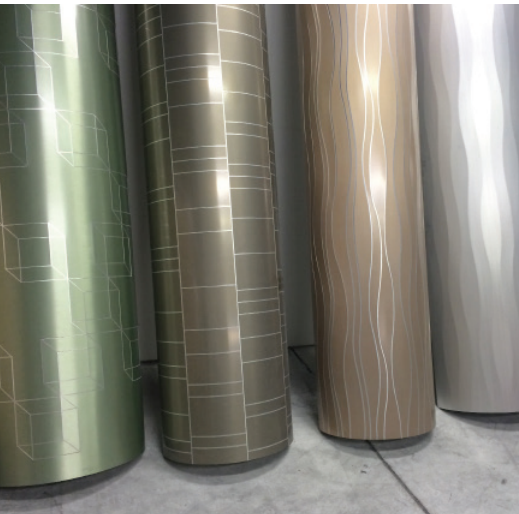

# FINISHES

## Móz Grains (aluminum or stainless) +more grains available online

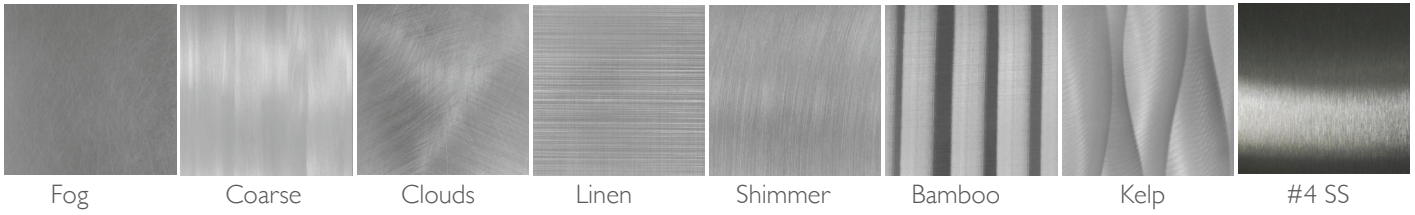

## Móz Colors (aluminum only) +more colors available online

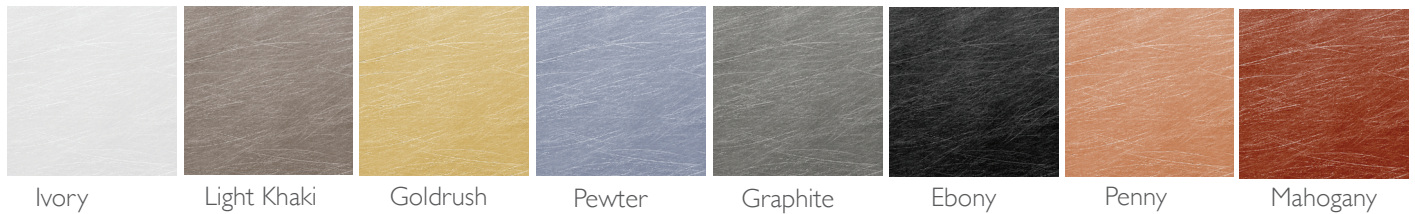

## Engravings (aluminum only) +more colors available online

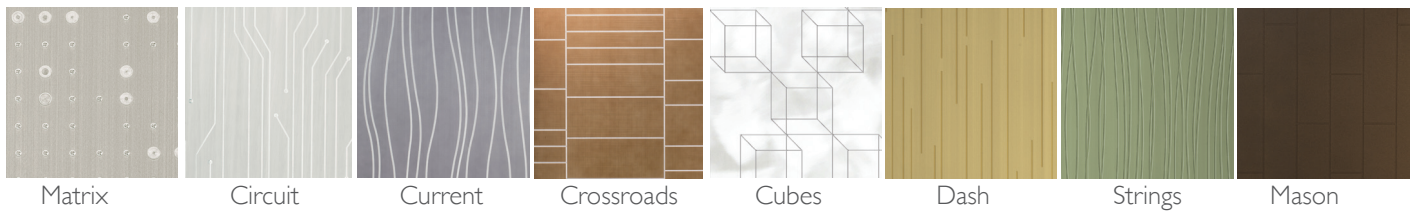

## Powder Coatings – Tiger Drylac® NEW

## Fluoropolymer (PVDF) Coatings – Fluropon® by Valspar or Duranar® by PPG NEW

contact coating manufacturers for complete color charts



## Embossed Stainless NEW +more patterns available

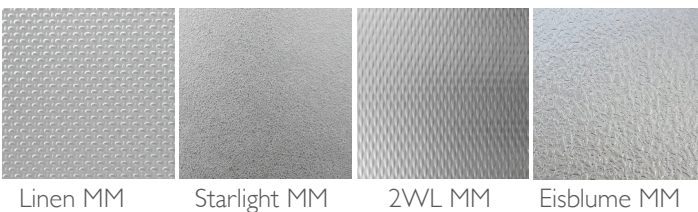

Fluropon® or Duranar® Fluoropolymer (PVDF) Resin coatings provide exceptional resistance to harsh environments, sunlight, moisture and temperature. They are an excellent choice for exterior architectural applications. They are warranted against fading, cracking and peeling for 20 years.

## Contact us for custom color matching and digital graphic applications!

View the entire Moz Color Palette online at [mozdesigns.com](http://mozdesigns.com).



Metals + Architectural Products



Móz Designs has been a leader in decorative metal surfaces since 1989. Based in Oakland, California, Móz metals and products are USA designed, sourced and manufactured with LEED points available for recycled content.