

Móz CC200 Oval Column Covers



RFQ - Request for Quote

CONTACT INFORMATION

Company: _____
 Name: _____
 Address: _____
 City, State: _____ Zip: _____
 Phone: _____ Fax: _____
 Email: _____

PROJECT INFORMATION

Date: _____
 Job Name: _____
 City/State: _____
 Install Date: _____ Bid Due Date: _____
 Ship To (Zip Code): _____
 Arch/Designer: _____

SIZE:

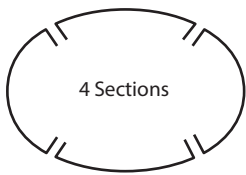

Minimum 24" x 36"
 Maximum 48" x 90"

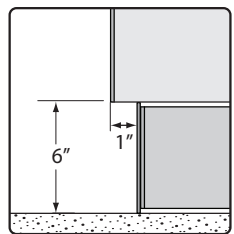
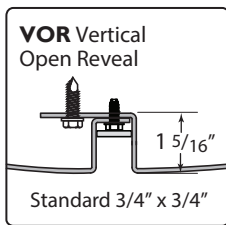
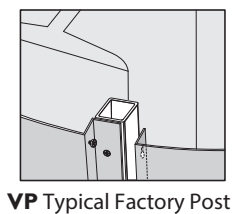
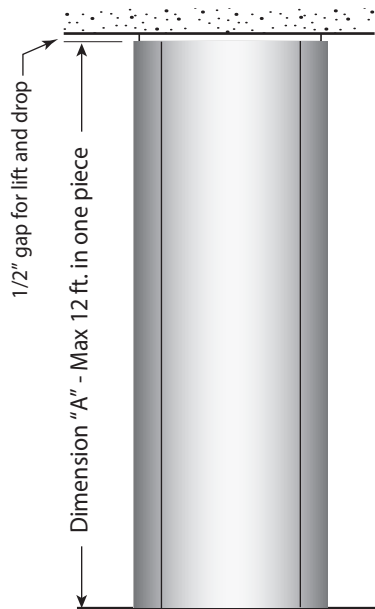

RC Recessed Capital/
RB Recessed Base
 6" Standard height

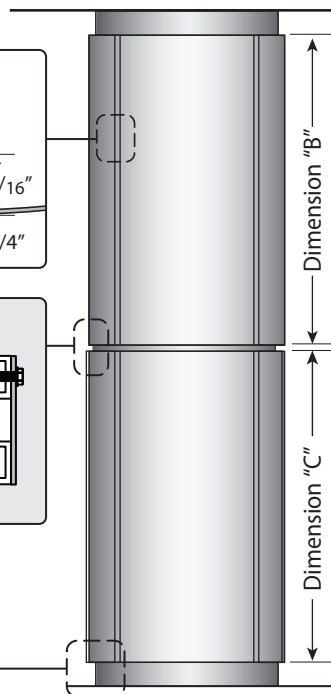
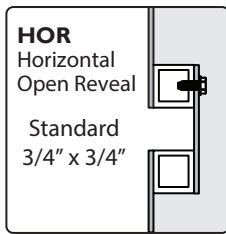

STANDARD FEATURES		
Quantity		
Size - min. 24"x 36" / max. 48" x 90" <small>(Allow 1 5/16" clearance behind finish column face)</small>		
Vertical Butt Joint	Standard	
Number of Sections	4	
Dimension "A": Finished Column Cover Height *		
Material: Aluminum (AL) or Stainless Steel (SS)	AL	SS
Color		
Grain		
Polycoat Finish Gloss (GL) or Satin (SA)	GL	SA

*For columns higher than 12 ft. please contact us.

OPTIONAL ADD-ONS			
Dimension "B" Upper Cover Height			
Dimension "C" Lower Cover Height			
Recessed Capital (RC) Standard 6" height	No	Yes	
Recessed Base (RB) Standard 6" height	No	Yes	
Vertical Open Reveal (VOR) <small>(Quantity should match number of sections)</small>	No	Yes	Qty:
Horizontal Open Reveal (HOR) <small>(For more than 1 please contact us)</small>	No	Yes	Qty:

CUSTOM OPTIONS	
Tapered Up or Down	Please contact us
Perforated (PF)	Please contact us
Exterior Finish	Please contact us