

# Móz Room Dividers with cables

## Technical Information



Our room divider kits are a creative way to redefine your office, entryway or meeting room. We offer two styles - flat or curved - in several base materials. Each kit arrives ready to install; all panels and hardware are included.

### STANDARD FEATURES

- Standard 3-panel kits available in 5' and 8' panel heights. Each panel is 3' wide and double-sided.
- Standard material thickness is .090" solid-core aluminum. Also available in .063" Perforated Aluminum with a 3/4" perimeter edge frame trim.
- Choose from any of our Classic, Blendz, or Graphix colors and our etched grains to decorate your panels. Perforated panels only available in Classic colors.
- Available in Polycoat Gloss or Matte finish.
- Includes all hardware and attachments - Cables, grippers and turnbuckles for affixing floor to ceiling.

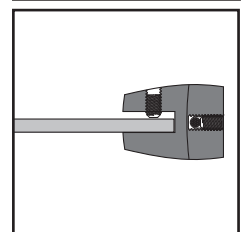
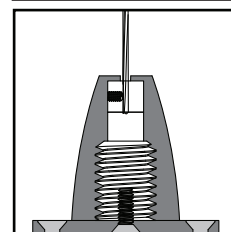
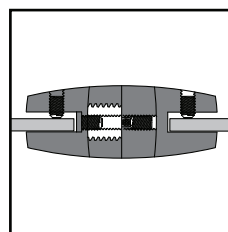
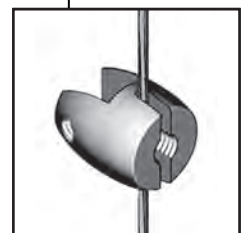
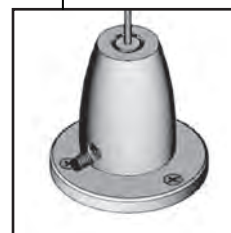
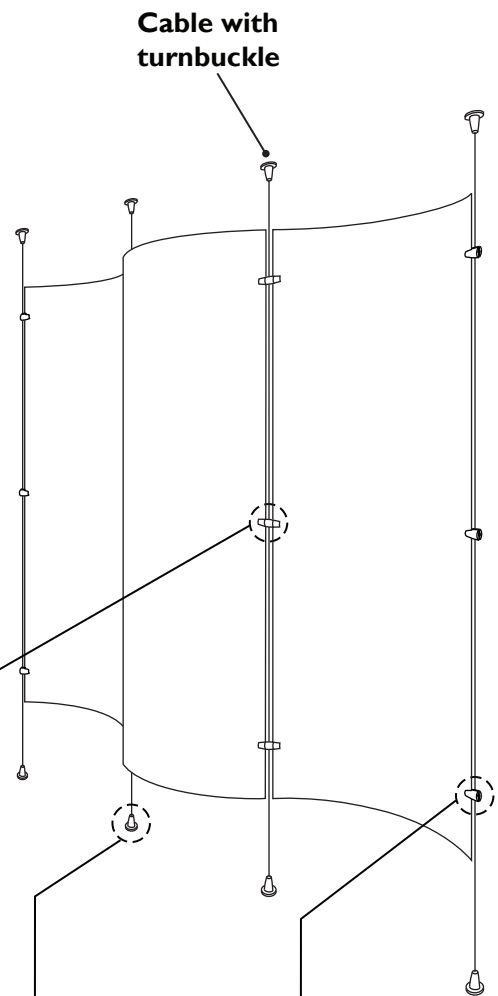
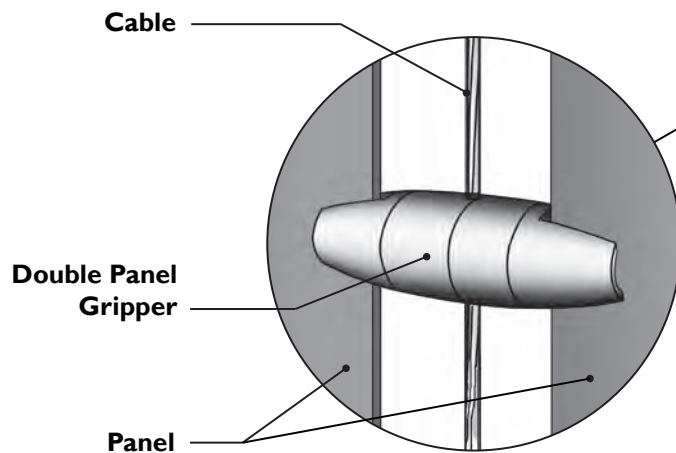

Double Panel Gripper

Turnbuckle

Single Panel Gripper

### OPTIONAL ADD-ONS

- Extra panels, available in 5' and 8' heights. Each panel comes with corresponding hardware and attachments.
- Stainless Steel.
- Custom sizes and/or panel shapes.
- Color matching.

## PRODUCT OPTIONS

**9' x 5' Kit** - Standard 3-panel kit.  
3' wide x 5' high panels

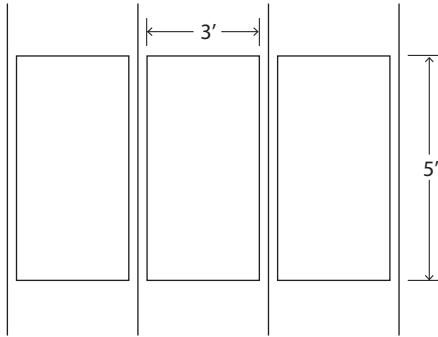

RDFC335 Kit - 9' x 5' **Flat** Panels

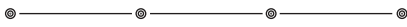

RDCC335 Kit - 9' x 5' **Curved** Panels



**5' add-on panels**

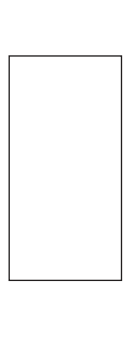

RDFC335A - **Flat**

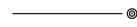

RDCC335A - **Curved**

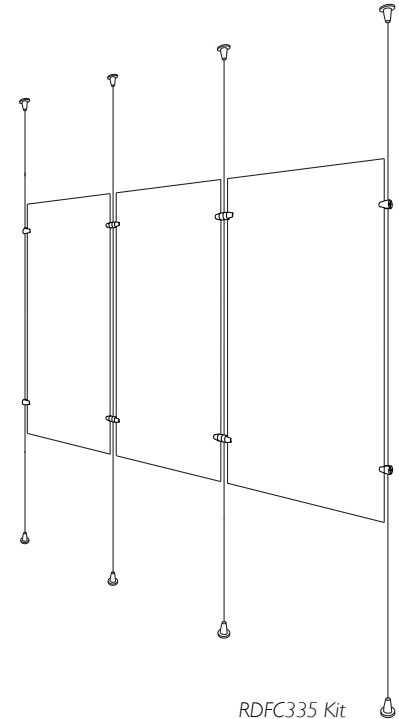

**9' x 8' Kit** - Standard 3-panel kit.  
3' wide x 8' high panels

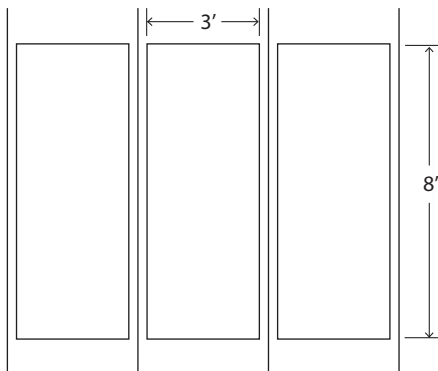

RDFC338 Kit - 9' x 8' **Flat** Panels



RDCC338 Kit - 9' x 8' **Curved** Panels



**8' add-on panels**

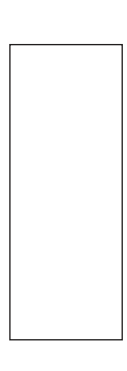

RDFC338A - **Flat**



RDCC338A - **Curved**

